

EPCI-5150-5925-SMT5

SMT CIRCULATOR

REV 1.0.0

SPECIFICATIONS

FREQ (MHz)	PART NUMBER	INSERTION LOSS (dB)	ISOLATION (dB)	VSWR	POWER (W)	OPERATING TEMP (°C)	IMPEDANCE (Ω)
5150-5925	EPCI-5150-5925-SMT5	0.5	16	1.38	20	-40 to +110	50

All specifications are subject to change without notice.

MECHANICAL OUTLINE

* Dimensions are *mm*

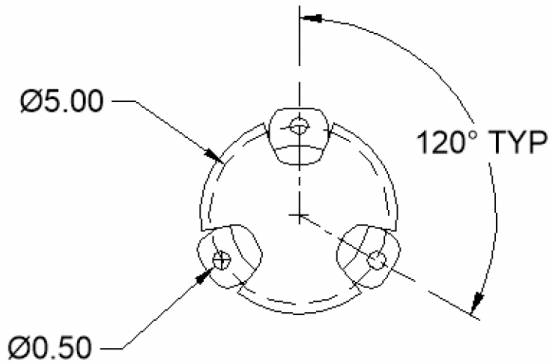
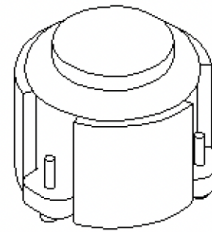
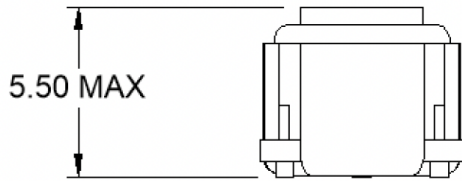

Notes:

1. Tolerances: ±0.20mm
2. Coplanarity specification: 0.10mm maximum
3. Pins and housing are silver (Ag) plated
4. Reflow Temp: 260°C max for 10 seconds