

EPCI-3300-3800-SMT

SMT CIRCULATOR

REV 1.0.0

SPECIFICATIONS

FREQ (MHz)	PART NUMBER	INSERTION LOSS (dB)	ISOLATION (dB)	VSWR	POWER (W)	OPERATING TEMP (°C)	IMPEDANCE (Ω)
3300-3800	EPCI-3300-3800-SMT	0.3	21	1.2	100	-40 to +125	50

All specifications are subject to change without notice.

MECHANICAL OUTLINE

* Dimensions are *mm*

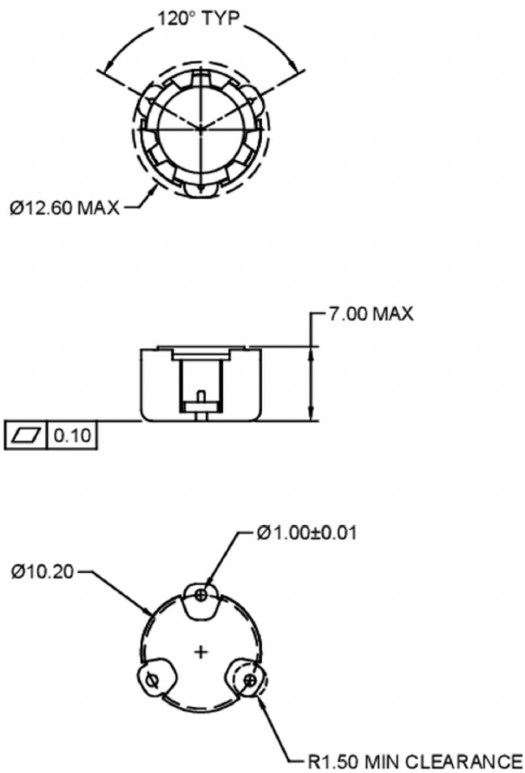

Notes:

1. Tolerances: ± 0.20 mm
2. Coplanarity specification: 0.10mm maximum
3. Pins and housing are silver (Ag) plated
4. Reflow Temp: 260°C max for 10 seconds