

EPCI-2490-2690-SMT

SMT CIRCULATOR

REV 1.0.0

SPECIFICATIONS

FREQ (MHz)	PART NUMBER	INSERTION LOSS (dB)	ISOLATION (dB)	VSWR	POWER (W)	OPERATING TEMP (°C)	IMPEDANCE (Ω)
2490-2690	EPCI-2490-2690-SMT	0.3	20	1.17	30	-40 to +110	50

All specifications are subject to change without notice.

MECHANICAL OUTLINE

* Dimensions are *mm*

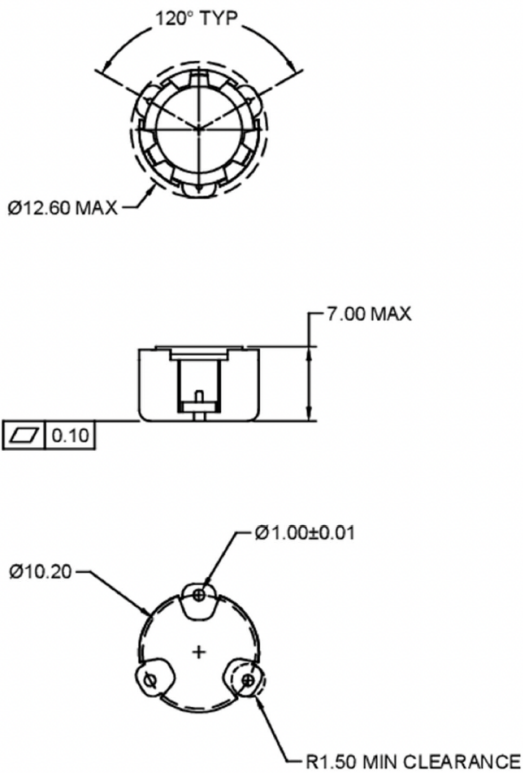

Notes:

1. Tolerances: ± 0.20 mm
2. Coplanarity specification: 0.10mm maximum
3. Pins and housing are silver (Ag) plated
4. Reflow Temp: 260°C max for 10 seconds