

Q3XB-4000R

SURFACE MOUNT 3dB 90° HYBRID COUPLERS

REV 1.0.0



APPLICATIONS

- Signal Splitting/Combining
- Balanced Amplifier Circuit
- I/Q Modulators/Demodulators
- Analog Phase Shifters
- Analog Variable Attenuators
- Microwave Mixers
- Image Reject Mixers
- And More...

FEATURES

- Excellent RF performance
- Low insertion loss
- Tight coupling
- Low amplitude balance
- Close phase tracking
- Industry standard sizes and footprint
- Dimensionally stable materials for best CTE match

SPECIFICATIONS

TABLE 1: TYPICAL SPECIFICATIONS*

FREQ (GHz)	POWER (W)	PART NUMBER	INSERTION LOSS (dB)	AMPLITUDE BALANCE (dB)	ISOLATION (dB)	VSWR	PHASE BALANCE	OPERATING TEMP (°C)	ΘJC (°C/W)
1.7 - 6.0	50	Q3XB-4000R	0.30	± 1	18	1.25	± 2°	-55 to +85	37.5
1.7 - 4.7	85		0.17						
4.7 - 6.0	50		0.30						

* Units tested with small signal using Electro-Photonics test board at 25°C. Specifications subject to change without notice.

† Peak Power Handling = Max CW Power x 10 @ 10% DC 10µs PW

MECHANICAL OUTLINE

* Dimensions are inches [millimeters].

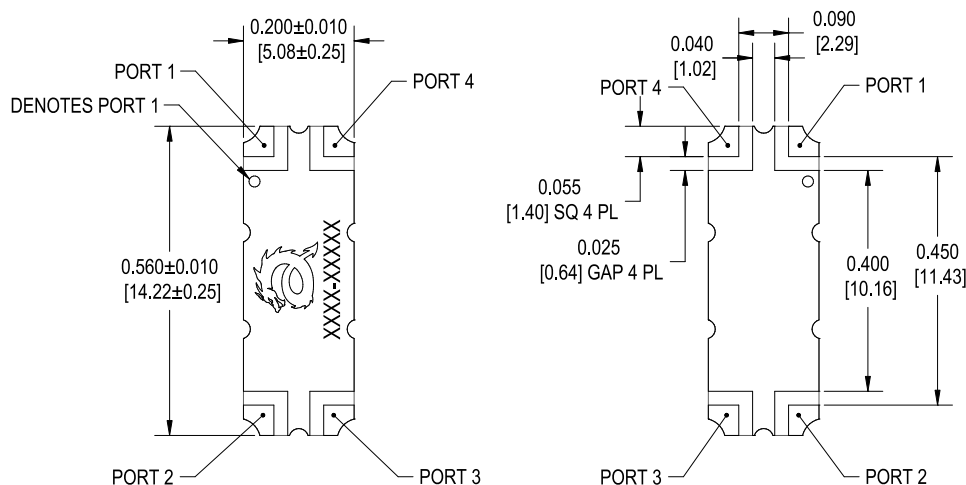

Q3XB-4000R

SURFACE MOUNT 3dB 90° HYBRID COUPLERS

REV 1.0.0

TYPICAL PERFORMANCE

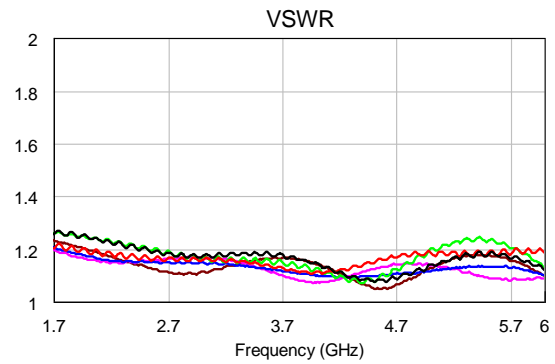
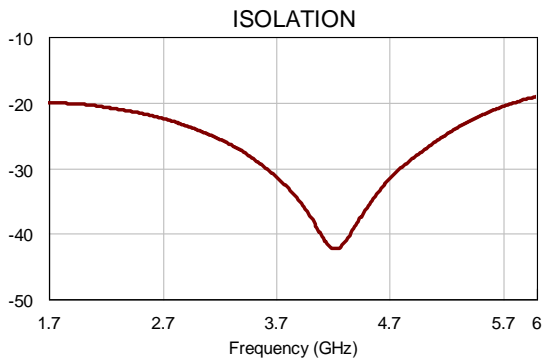
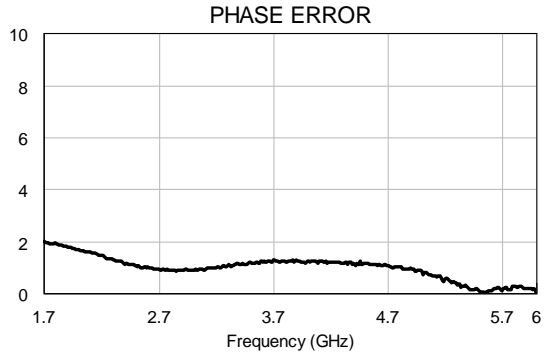
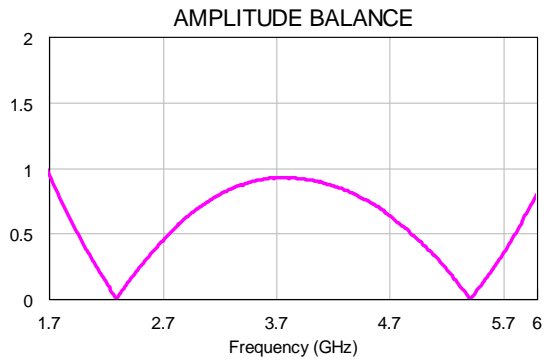
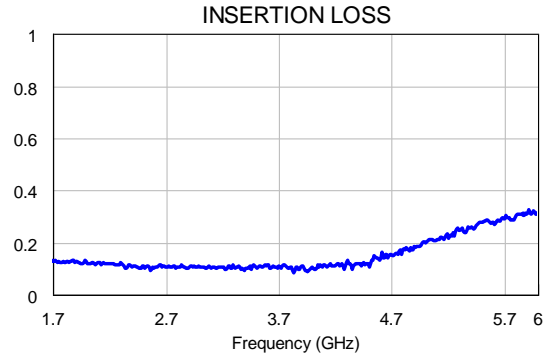
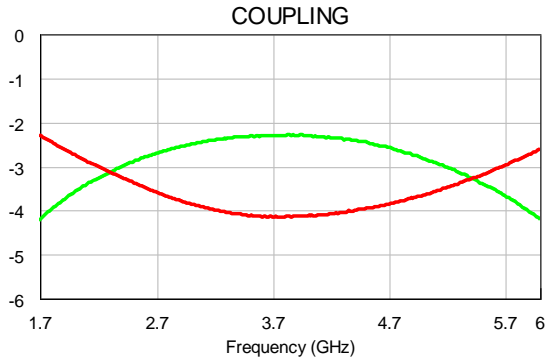

POWER DERATING

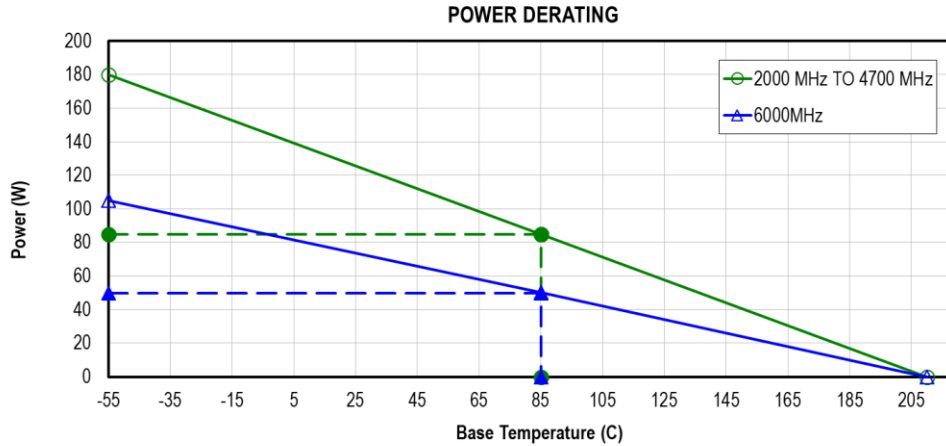

PIN CONFIGURATION

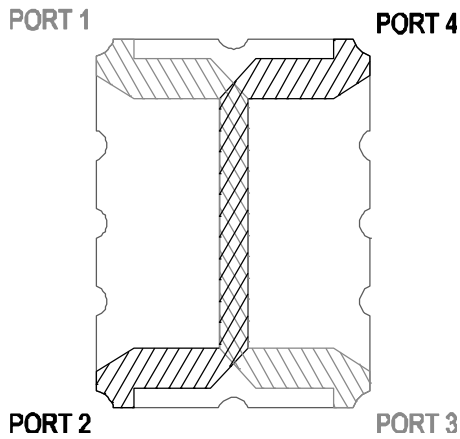

TABLE 2: SPLITTER CONFIGURATION*

PORT 1	PORT 2	PORT 3	PORT 4
IN	ISO	-90°	0°
ISO	IN	0°	-90°
-90°	0°	IN	ISO
0°	-90°	ISO	IN

* Signals will split into -3dB amplitude in quadrature. A small fraction of the signal will appear at the isolated port due to non-ideal isolation.

TABLE 3: COMBINER CONFIGURATION

PORT 1	PORT 2	PORT 3	PORT 4
-90°	0°	ISO	OUT
0°	-90°	OUT	ISO
ISO	OUT	-90°	0°
OUT	ISO	0°	-90°

† Combining signals are applied in quadrature with equal amplitude. Unequal amplitude signals will generate small signal appearing at the isolated port.

MOUNTING

Electro-Photonics test board is designed using 30 mil RO4350B material. Land pattern design must be taken into consideration when using a different thickness and/or dielectric constant for optimal performance.

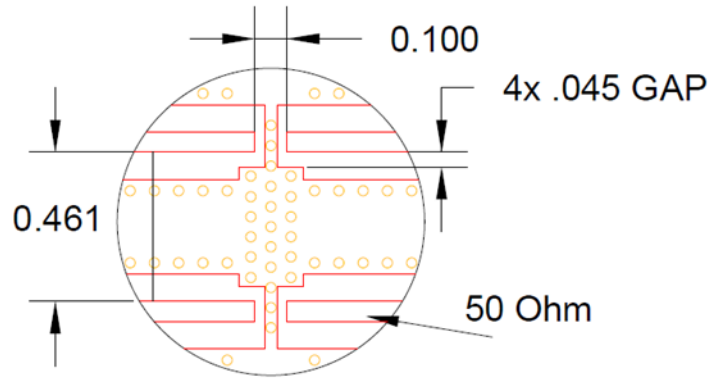

LEAD-FREE SOLDER PROFILE

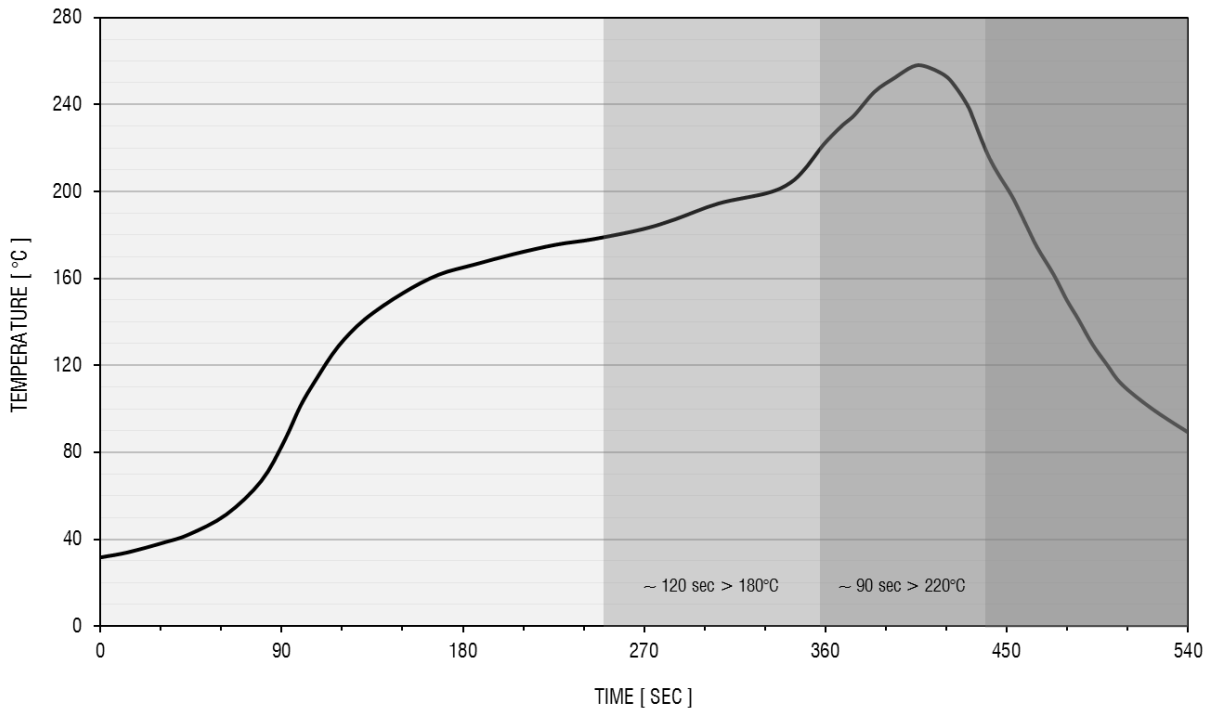

Q3XB-4000R

SURFACE MOUNT 3dB 90° HYBRID COUPLERS

REV 1.0.0

ORDERING INFO

Parts come in lose pieces in plastic bag; Tape & Reel is available upon request.

Q 3 X B - 4 0 0 0 R - T
 ① ② - ③ ④ - ⑤

①	②	③	④	⑤
PRODUCT CODE	SIZE	FREQUENCY	PLATING	PACKAGING
QUADRATURE 3dB CROSSOVER HYBRID	A = .250 X .200 B = .560 X .200 G = .560 X .350 D = .650 X .480	MHz (SEE TABLE 1)	R = IMMERSION TIN E = ENIG (ELECTROLESS NICKEL IMMERSION GOLD)	= BULK T = TAPE & REEL (MOQ REQ'D FOR TAPE & REEL)

The Q3XB-4000R is lead free, RoHS compliant product.



Q3XB-4000R

SURFACE MOUNT 3dB 90° HYBRID COUPLERS

REV 1.0.0

EVALUATION BOARD P/N: 722-0006-02-E01

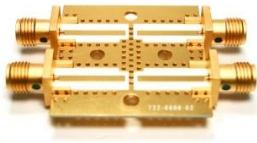

The 722-0006-02-E01 is a high-performance RF/MW evaluation board for SMD .560 x .200 couplers. Each board comes with four high performance end launch connectors that are easy to assemble.

ELECTRICAL SPECIFICATIONS

PARAMETER	SPECIFICATION
FREQUENCY RANGE	DC – 14 GHz
INSERTION LOSS, MAX	0.7 dB
VSWR, MAX	1.20:1

RETURN LOSS AND INSERTION LOSS

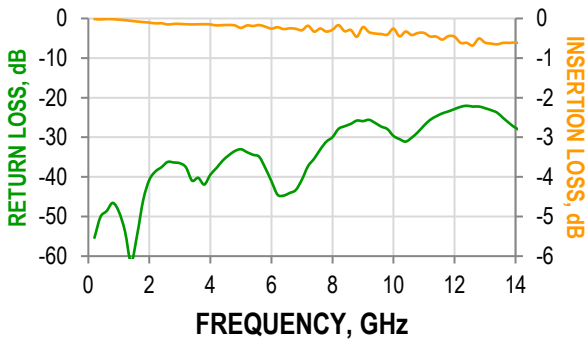

VSWR

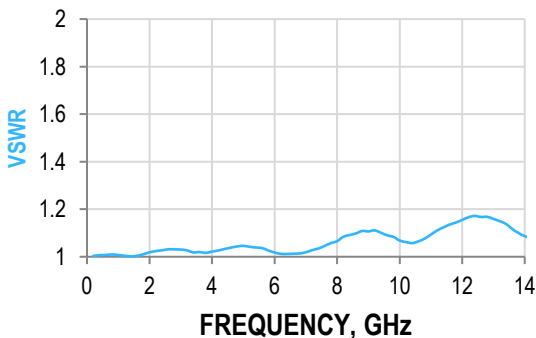

MECHANICAL SPECIFICATIONS

PARAMETER	SPECIFICATION
MATING INTERFACE	SMA (F)
TEMPERATURE RANGE	-45 TO +125 °C
BOARD MATERIAL	RO4350B
BOARD THICKNESS	.030
COPPER WEIGHT	1 OZ
FINISH	ENIG

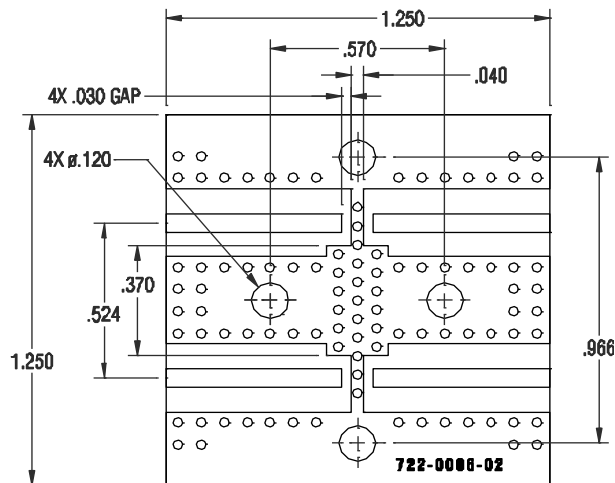

ORDERING INFO

722	-	0006-02	-	E01
PRODUCT		BOARD		CONFIG
			.560 x .200 COUPLER	4x SMA

COUPLERS