

# FRFS-A0800

RF FIXTURE FOR RF2186 AMPLIFIER

REV 1.00

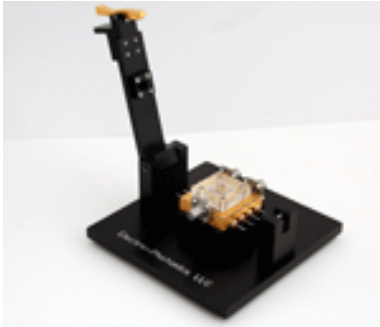

The FRFS-A0800 is a high performance RF/Microwave production type fixture for testing RF Micro Devices amplifier P/N RF2186. This fixture is constructed to provide repeatable measurements in a production environment. The FRFS-A0800 test fixture feature fast load/unload clamshell type cover.

## ELECTRICAL/ MECHANICAL SPECIFICATIONS

PARAMETER	SPECIFICATION*
FREQUENCY RANGE	DC – 2 GHz
RF PORTS	3
DC PINS	8
MATING INTERFACE	SMA JACK (FEMALE)

## PACKAGE FOOTPRINT

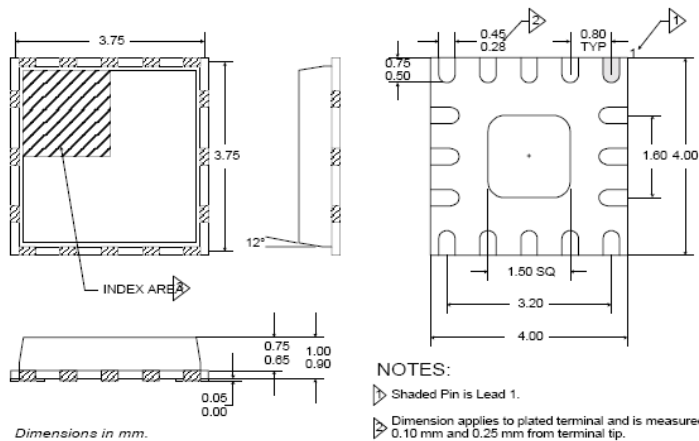

**NOTES:**

- ▶ Shaded Pin is Lead 1.
- ▶ Dimension applies to plated terminal and is measured 0.10 mm and 0.25 mm from terminal tip.
- ▶ The terminal #1 identifier and terminal numbering conv shall conform to JEDEC GS-1 SPP-Q12. Details of termin identifier are optional, but must be located within the zo indicated. The identifier may be either a mold or marke feature.
- 4 Pins 1 and 9 are fused.
- 5 Package Warpage: 0.05 max.

**Package Style: LCC, 16-Pin**

Electro-Photonics LLC reserves the right to modify drawings, configurations, specifications, and design at any time without prior notification.

# FRFS-A0800

RF FIXTURE FOR RF2186 AMPLIFIER

REV 1.00

## WIRING DIAGRAM

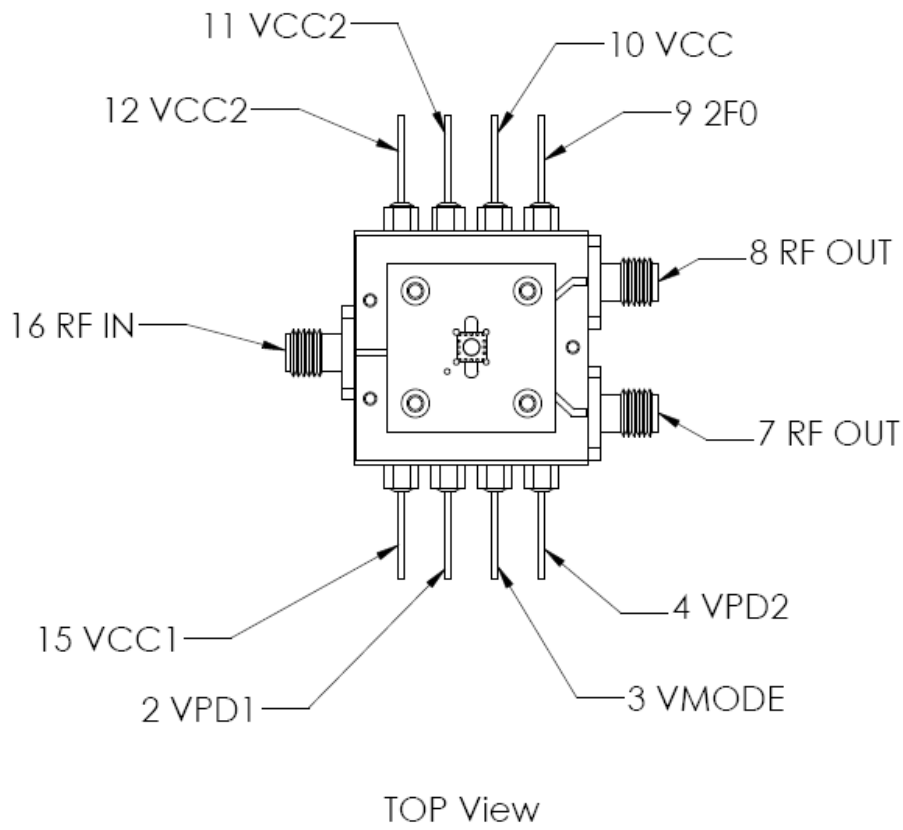

Electro-Photonics LLC reserves the right to modify drawings, configurations, specifications, and design at any time without prior notification.

# FRFS-A0800

RF FIXTURE FOR RF2186 AMPLIFIER

REV 1.00

## GALLERY

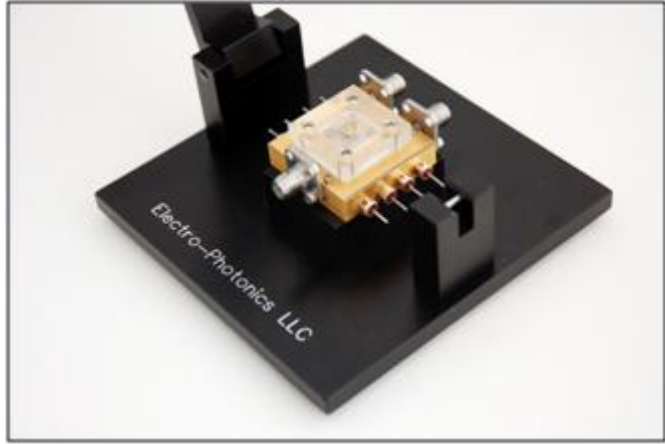
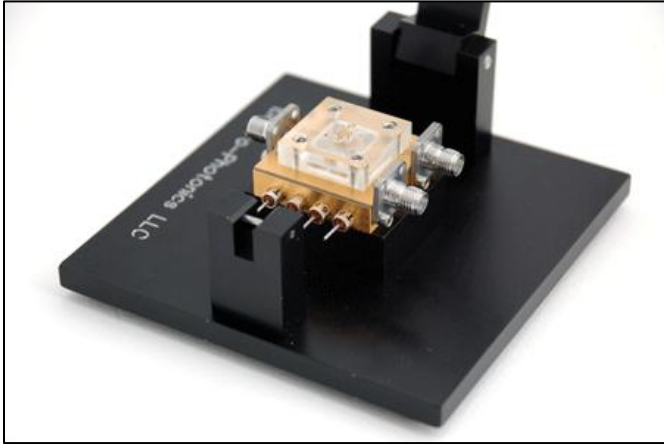
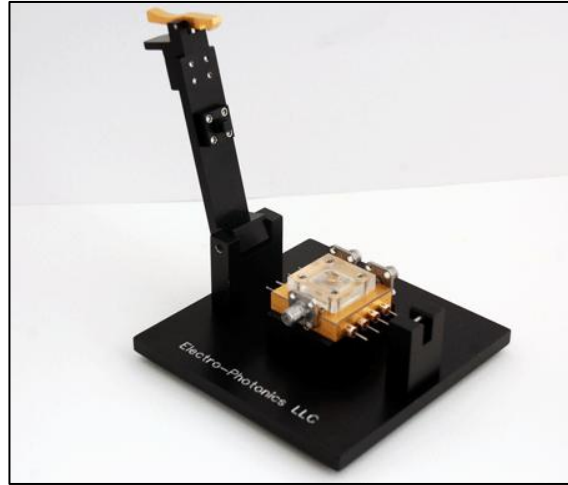
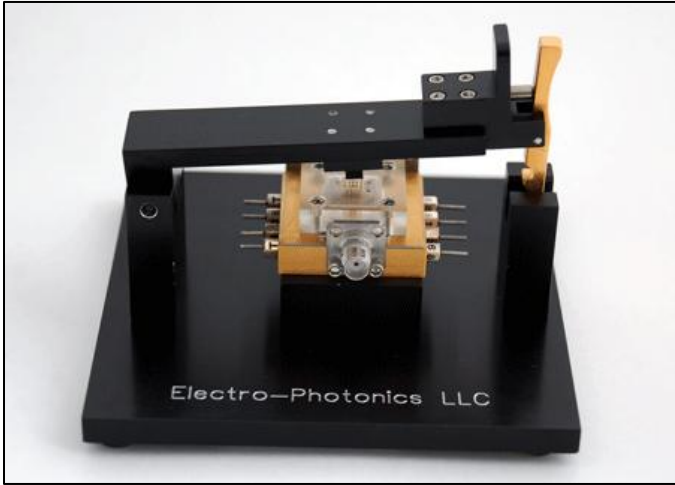

Electro-Photonics LLC reserves the right to modify drawings, configurations, specifications, and design at any time without prior notification.

# FRFS-A0800



RF FIXTURE FOR RF2186 AMPLIFIER

REV 1.00

## CUSTOMIZATION

The FRFS-A0800 can be customized for number of similar DUT's in this or similar footprint. In addition, Electro-Photonics can design a custom solution per your requirements.

Please consult sales [sales@electro-photonics.com](mailto:sales@electro-photonics.com) to discuss customization options.

## ORDERING INFO

**FRFS**

PRODUCT CODE

-

**A0800**

FIXTURE CODE

FIXTURES

Electro-Photonics LLC reserves the right to modify drawings, configurations, specifications, and design at any time without prior notification.