

Q3XA-3500R

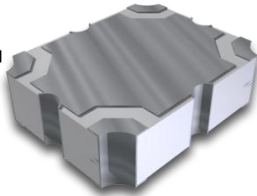

APPLICATIONS

- Signal Splitting/Combining
- Balanced Amplifier Circuit
- I/Q Modulators/Demodulators
- Analog Phase Shifters
- Analog Variable Attenuators
- Microwave Mixers
- Image Reject Mixers
- Integrated Circuits
- And More...

FEATURES

- Excellent RF performance; low insertion loss, tight coupling, low amplitude balance, close phase tracking
- Compact and low profile
- Industry standard sizes and footprint
- Optimized for thermal and RF performance
- Dimensionally stable materials for best CTE match

SPECIFICATIONS

TABLE 1: TYPICAL SPECIFICATIONS*

FREQ (MHz)	POWER (W)	PART NUMBER	INSERTION LOSS (dB)	AMPLITUDE BALANCE (dB)	ISOLATION (dB)	VSWR	PHASE BALANCE	OPERATING TEMP (°C)	ΘJC (°C/W)
3200-3800	20	Q3XA-3500R	0.22	± 0.2	24	1.20	± 3°	-55 to +95	49.3

* Units tested with small signal using Electro-Photonics testboard at 25°C. Specifications subject to change without notice.

† Please consult sales (sales@electro-photonics.com) for custom footprints, sizes, and/or specifications.

MECHANICAL OUTLINE

* Dimensions are inches [millimeters].

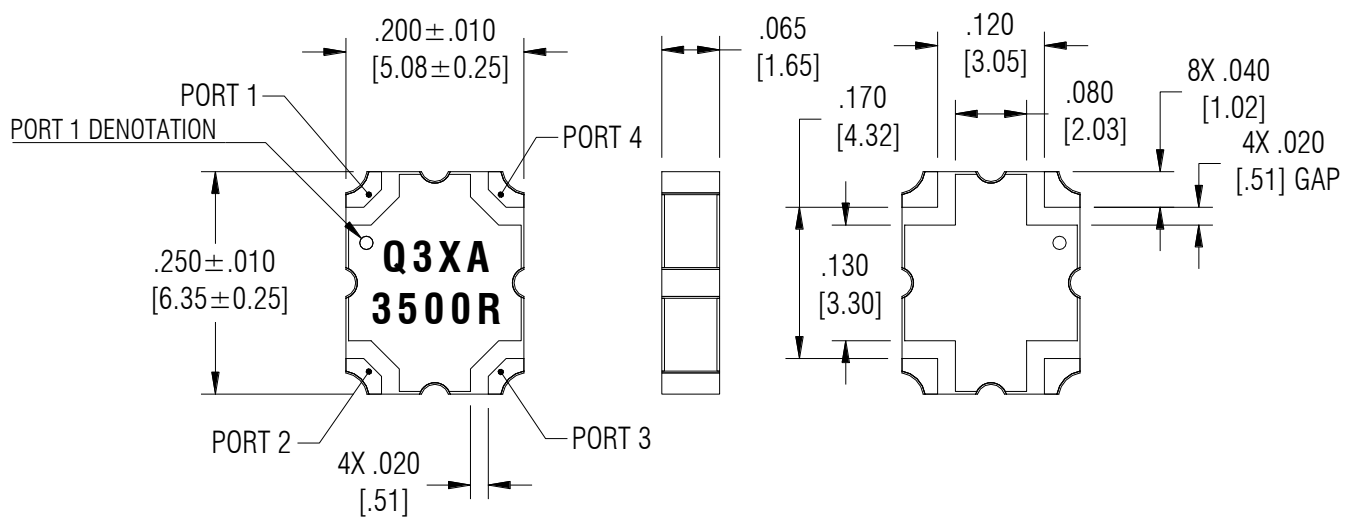

Q3XA-3500R

SURFACE MOUNT 3dB 90° HYBRID COUPLERS

REV 1.1.0

TYPICAL PERFORMANCE

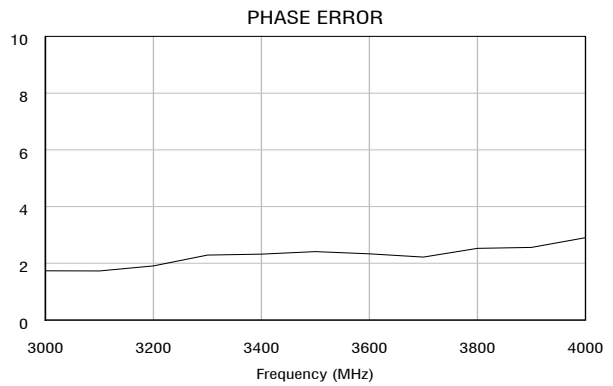
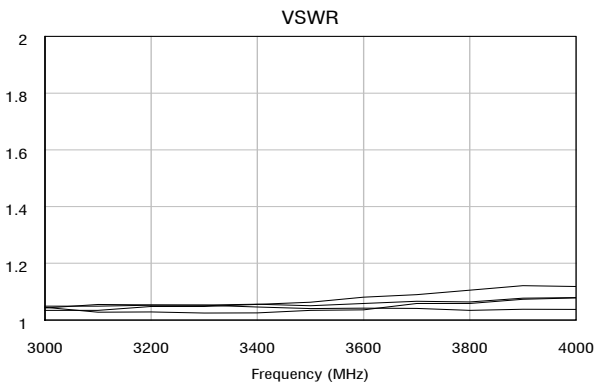
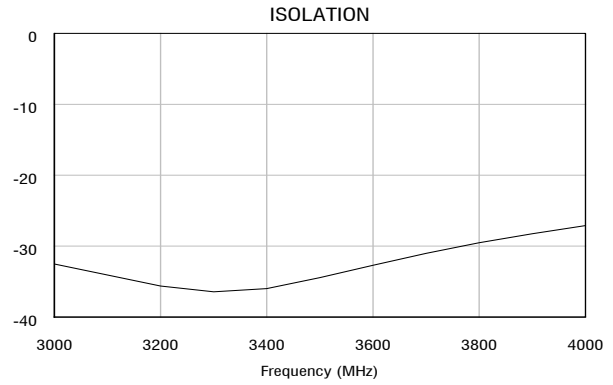
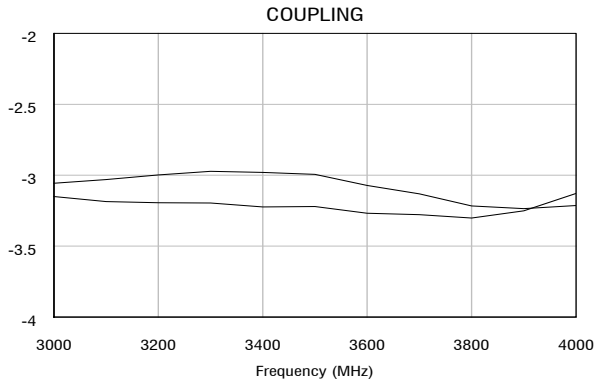

POWER DERATING

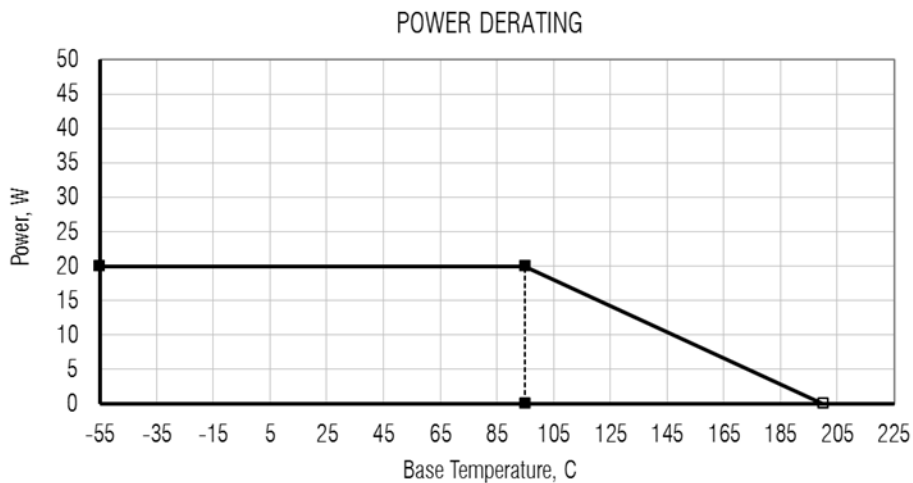

Q3XA-3500R

PIN CONFIGURATION

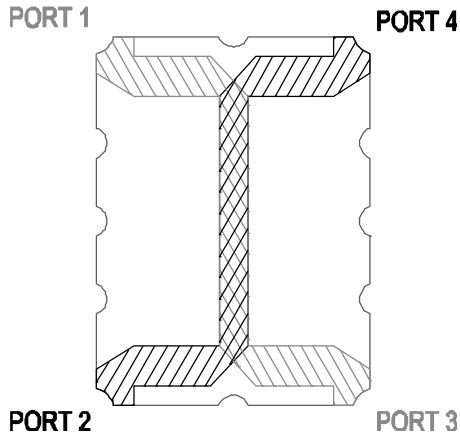

TABLE 2: SPLITTER CONFIGURATION*

PORT 1	PORT 2	PORT 3	PORT 4
IN	ISO	-90°	0°
ISO	IN	0°	-90°
-90°	0°	IN	ISO
0°	-90°	ISO	IN

* Signals will split into -3dB amplitude in quadrature. A small fraction of the signal will appear at the isolated port due to non-ideal isolation.

TABLE 3: COMBINER CONFIGURATION†

PORT 1	PORT 2	PORT 3	PORT 4
-90°	0°	ISO	OUT
0°	-90°	OUT	ISO
ISO	OUT	-90°	0°
OUT	ISO	0°	-90°

† Combining signals are applied in quadrature with equal amplitude. Unequal amplitude signals will generate small signal appearing at the isolated port.

MOUNTING FOOTPRINT

Electro-Photonics test board is designed using 30 mil RO4350B material. Land pattern design must be taken into consideration when using a different thickness and/or dielectric constant in order to achieve optimal performance.

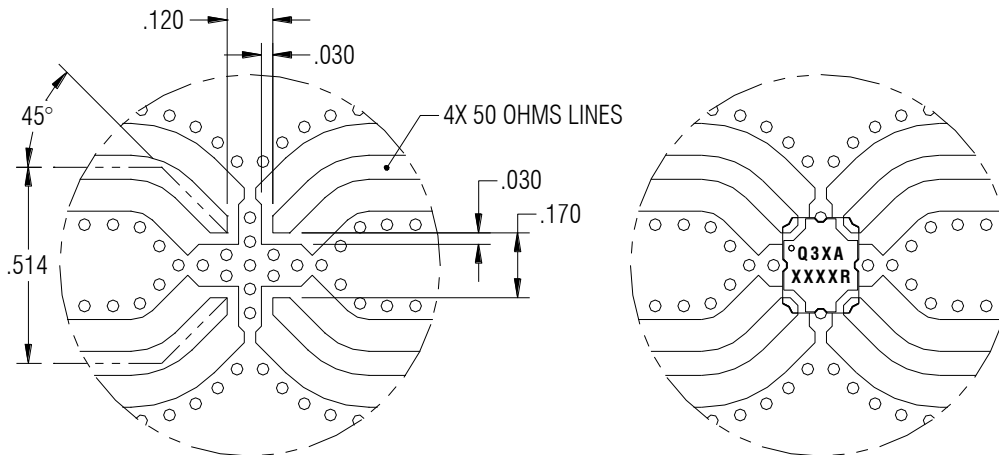

Q3XA-3500R

SURFACE MOUNT 3dB 90° HYBRID COUPLERS

REV 1.1.0

ORDERING INFO*

* Consult sales (sales@electro-photonics.com) for custom configuration, size, footprint, and/or specifications. Tape & Reel available upon request (with minimum order quantities).

Q 3 X A - 3 5 0 0 R
① ② ③ ④

①	②	③	④
PRODUCT CODE	SIZE	FREQUENCY	PLATING
QUADRATURE 3dB CROSSOVER HYBRID	A = .250 X .200 B = .560 X .200 G = .560 X .350 D = .650 X .480	MHz (SEE TABLE 1)	R = IMMERSION TIN